

31 647 AP0 K500 COMPOSITE SINK WITH DRAINER

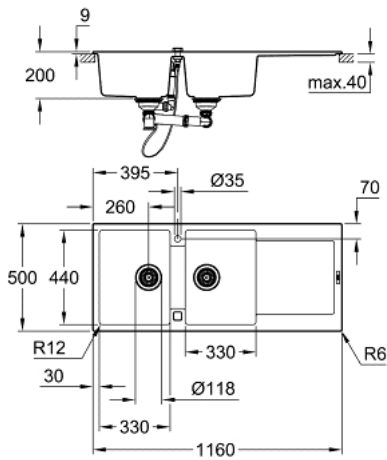

PRODUCT DESCRIPTION

- Colour: granite black
- model: K500 80-C 116/50 2.0 rev
- mounting type: top mount
- material: quartz composite
- GROHE Whisper
- min. cabinet size: 800 mm
- dimensions: 1160 x 500 mm
- 1 bowl: 330 x 440 x 200 mm
- 2 bowl: 330 x 440 x 200 mm
- outer radius: R6, inner bowl radius: R12
- GROHE FastFixation installation system
- sink mountable left or right
- cut-out: 1140 x 480 mm
- drainer: automatic waste fitting
- accessories included: automatic waste fitting with rotary handle, waste kit, basket strainer waste, mounting set
- optional push to open excenter (40 986 SD0)
- amount of fasteners included (top mount): 12
- heat resistant up to 180° C

31 647 AP0 **K500 COMPOSITE SINK WITH DRAINER**

SPARE PARTS, May 2022 – now

- 1: Plug (Spare part-nr. 42588SD1)
- 2: Waste trap (Spare part-nr. 42619000)
- 3: Cover element (Spare part-nr. 42590SD1)
- 4: Turning handle (Spare part-nr. 42586SD0)
- 5: Plug (Spare part-nr. 42589SD1)

